















Roca

SYRA-E

A5A8A2A..0

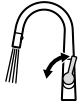

 P 	P bar	 MAX. 10	
 P 	P bar	MIN. 1  MAX. 5	2,5  3 
 T	°C	 -80 MAX. -45 MIN.	 -65 -50 
 Q (3 bar)	l/min	 5	 6

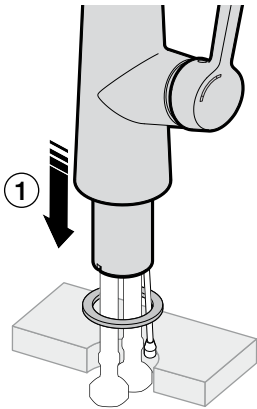
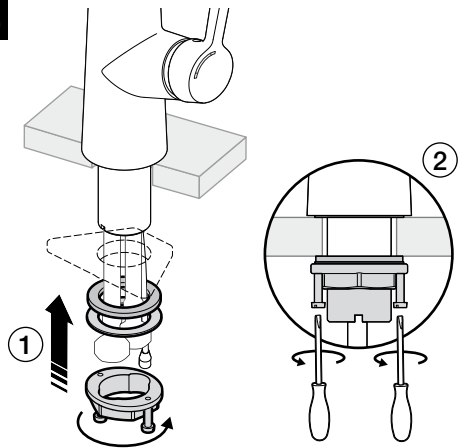
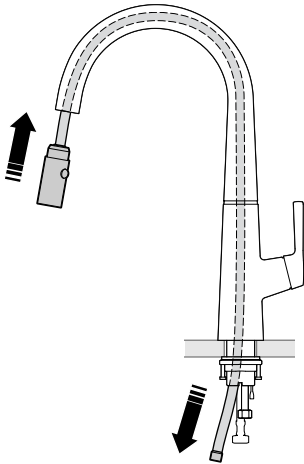
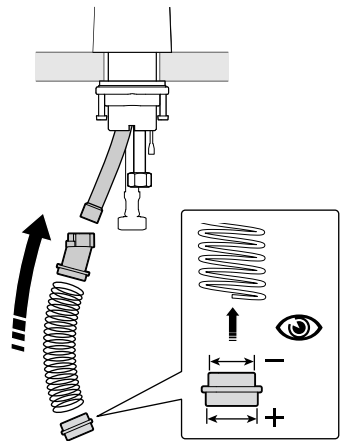
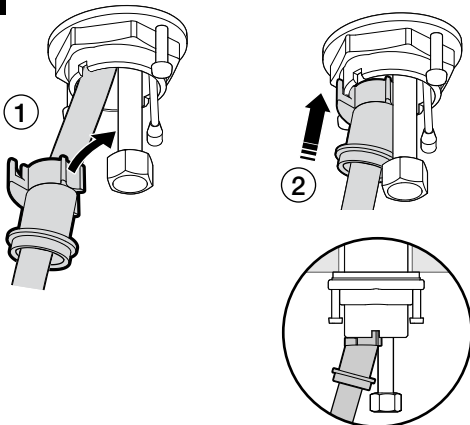
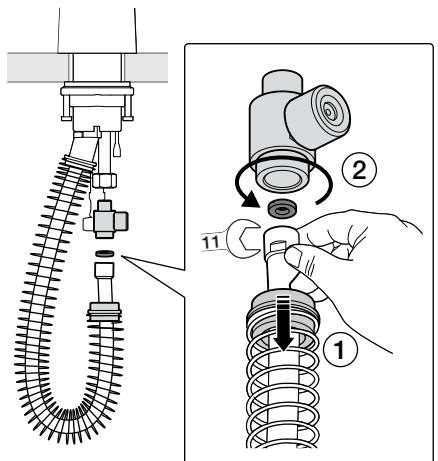
1**2****3****4****5****6**

7

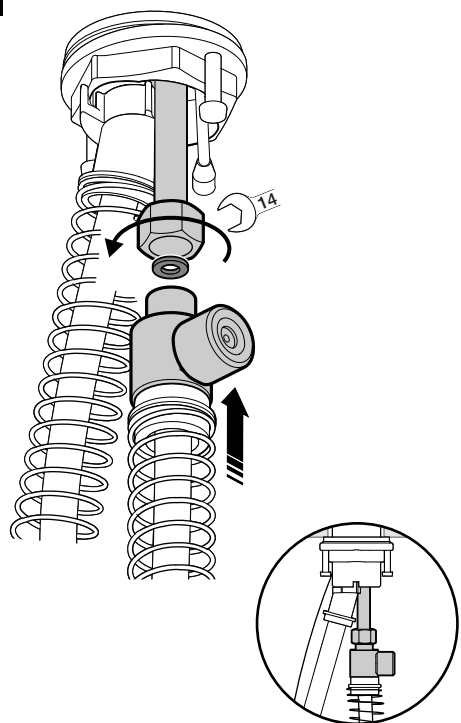

8

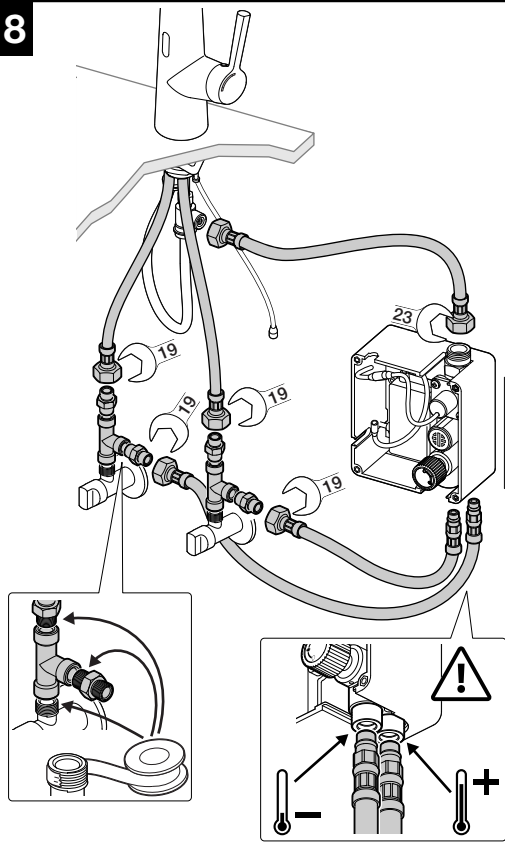

9

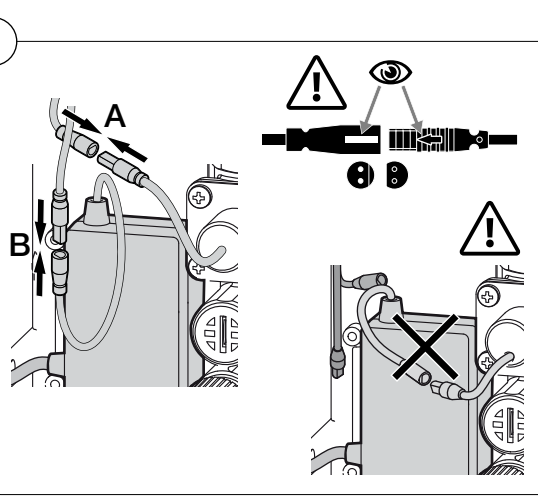
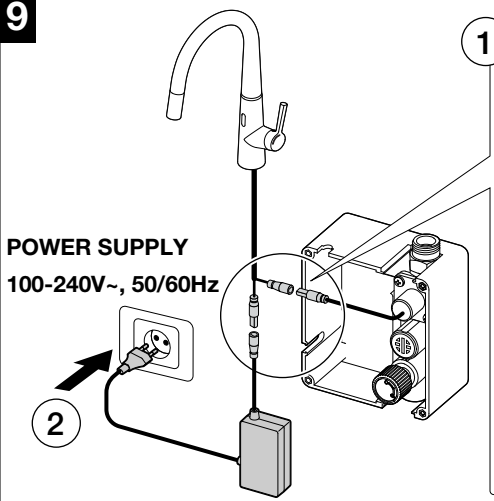

ES A lo largo de los 2 primeros minutos el led rojo parpadeará al activar el grifo en modo automático.

EN During the 2 first minutes, the red led will blink when the faucet is used in auto mode.

2. MODOS DE USO

USE MODES

2.1. MODO MONOMANDO

SINGLE LEVER MODE

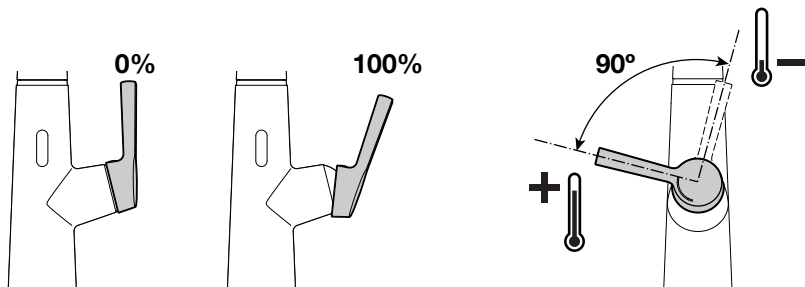

2.2 MODO AUTOMÁTICO

AUTO MODE

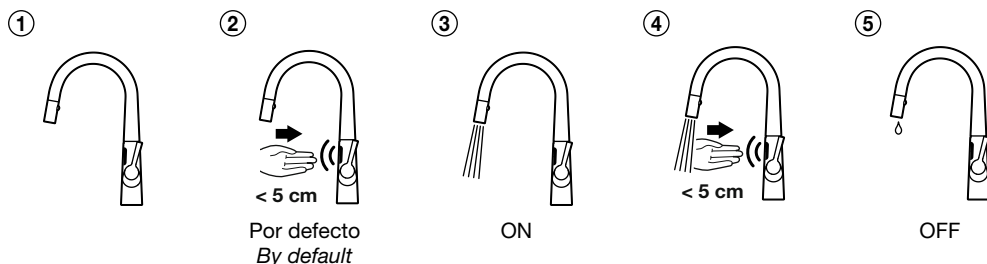

2.3 AUTOSTOP

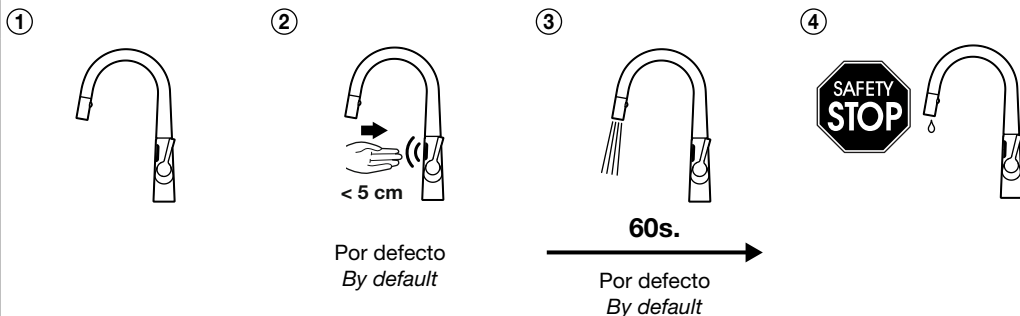

ES El flujo de agua se interrumpirá automáticamente pasados 60 segundos de su activación (ajuste por defecto), como medida de seguridad.

El grifo incorpora además un sistema que asegura el cierre del paso de agua al quedarse sin alimentación eléctrica durante el uso del mismo.

EN The flow will stop automatically after 60 seconds of use (default setting), as a safety feature. The tap has also a system which ensures that the tap shuts off if the batteries are run down or electric main supply is cut.

2.4 SELECCIÓN DE TEMPERATURA EN MODO AUTOMÁTICO

TEMPERATURE SELECTION IN AUTO MODE

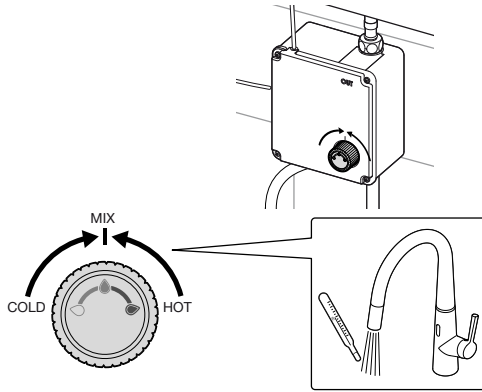

2.5 USO PULL DOWN

PULL DOWN USE

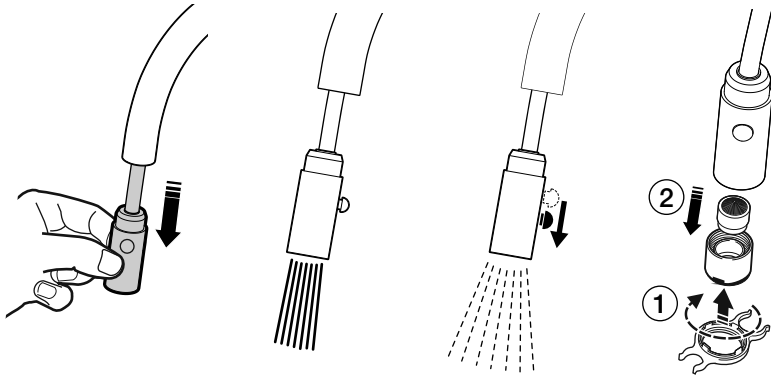

3. AJUSTES

ADJUSTMENTS

ES 3.1 AJUSTE DE DISTANCIA DE DETECCIÓN

El grifo se activa o desactiva al acercar la mano a menos de 5 cm. (ajuste por defecto). Esta distancia puede variarse en función de los requerimientos de instalación o preferencias del usuario.

⚠ Ajuste sólo posible durante los primeros 2 minutos tras la conexión eléctrica

①

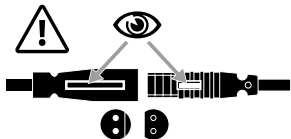

Desconectar y conectar la alimentación eléctrica. En el transcurso de los 2 primeros minutos, proceder con la secuencia indicada.

②

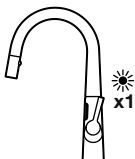

El LED emite un destello. Esperar 5 seg. para iniciar el proceso de ajuste.

③

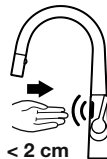

Colocar la mano frente al sensor a menos de 2cm. durante 5 seg. Es indiferente que haya o no flujo de agua.

④



Cuando el LED rojo del sensor empiece parpadear, retirar las manos. El paso de agua debe interrumpirse si estaba abierto.

⑤

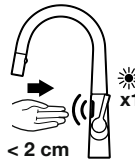

A los 3 seg. el grifo activará el paso de agua y el LED rojo emitirá 1 parpadeo por seg. durante 5 seg. dentro de los cuales se debe colocar la mano delante del sensor a menos de 2cm. El LED rojo pasará a estar activo y se cerrará el paso de agua.

⑥



Colocar la mano a la distancia deseada de ajuste, en el rango de 2 a 10 cm, y mantener durante 5 segundos.

⑦

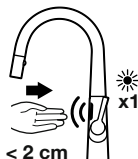

Tras 5 seg. el LED rojo se apagará y la distancia de detección habrá quedado fijada a un nuevo valor (2-10cm). Si no se presenta la mano frente al sensor o si se retira antes de los 5 segundos, el grifo quedará fijado con la distancia de detección más grande posible

⚠ ATENCIÓN: dependiendo del lugar de emplazamiento del grifo y de la manipulación de objetos en torno al mismo, es posible observar detecciones involuntarias. Si esto ocurriera, reducir la distancia de detección o ajustar el retardo de apertura y cierre del agua (Ver 3.2).

EN 3.1 DETECTION DISTANCE ADJUSTMENT

The faucet activates or deactivates by placing the hand closer than 5 cm. (default setting). This distance can be changed for installation requirements or user preferences.

⚠ This adjustment is only possible within the first 2 minutes after power supply connection

①

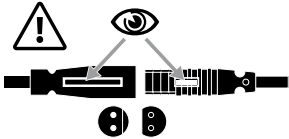

Unplug and plug the power supply. Within the first 2 minutes, proceed with the following steps.

②

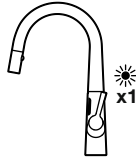

The LED blinks one time. Wait 5 sec. to start the adjustment process.

③

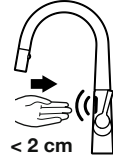

Place hand in front of the sensor closer than 2cm. for 5 sec. regardless of water flow.

④

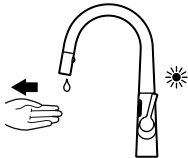

When the red LED of sensor starts to blink, remove hand. The water flow will stop, if it was open.

⑤

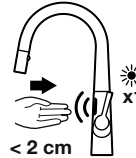

After 3 sec. the faucet starts water flow and the red LED blinks 1 time per sec. during 5 sec. Within those 5 sec. place hand in front of sensor closer than 2cm. The red LED remains lit and the water flow stops.

⑥

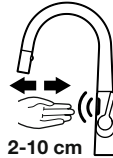

Place the hand to the desired distance, between 2 and 10 cm. and keep in place for 5 sec.

⑦

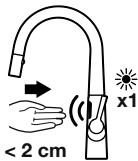

After 5 sec. the red LED turns off and the detection distance is set to the new value (2-10cm). If the hand is not placed or if it was removed from the sensor before 5 seconds, the faucet will be set to the longest detection distance (10cm).

⚠ WARNING: depending on the placement of the faucet and the handling of objects surrounding it, it is possible to experience involuntary detections. If that happens, reduce the detection distance or adjust the water flow delay time (See 3.2).

ES 3.2 AJUSTE RETARDO APERTURA Y CIERRE DEL AGUA

El grifo se activa o desactiva al detectar la mano al menos durante 0,5 seg. (ajuste por defecto). Este tiempo puede variarse en función de los requerimientos de instalación o preferencias del usuario.

⚠ Ajuste sólo posible durante los primeros 2 minutos tras la conexión eléctrica

①

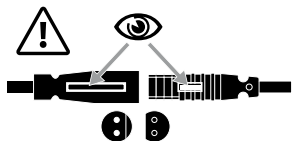

Desconectar y conectar la alimentación eléctrica. En el transcurso de los 2 primeros minutos, proceder con la secuencia indicada.

②

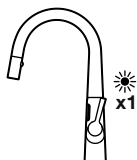

El LED emite un destello. Esperar 5 seg. para iniciar el proceso de ajuste.

③

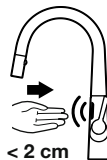

Colocar la mano frente al sensor a menos de 2cm. durante 5 seg. Es indiferente que haya o no flujo de agua.

④

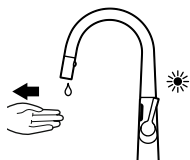

Cuando el LED rojo del sensor empiece parpadear, retirar las manos. El paso de agua debe interrumpirse si estaba abierto.

⑤

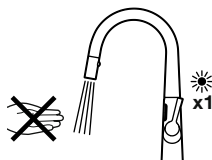

A los 3 seg. el grifo activará el paso de agua y el LED emitirá 1 parpadeo por seg. durante 5 seg. No colocar la mano.

⑥

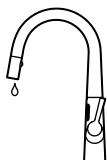

El grifo cerrará el paso de agua y el LED dejará de parpadear durante 3 seg.

⑦

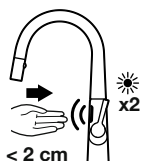

Se activará el paso de agua y el LED emitirá 2 parpadeos por seg. durante 5 seg. durante los cuales se debe colocar la mano a menos de 2cm. El LED dejará de parpadear y se cerrará el paso de agua. Retirar la mano antes de 3 seg.

⑧

Nivel 1
0,25 s.



El LED emitirá 1 parpadeo por seg. durante 5 seg. Si se desea Nivel 1 (0,25 seg), poner la mano a menos de 2cm. Si no se desea este ajuste, no colocar la mano.

⑨

Nivel 2
0,5 s.



El LED emitirá 2 parpadeos por seg. durante 5 seg. Si se desea Nivel 2 (0,5 seg), poner la mano a menos de 2cm Si no se desea este ajuste, no colocar la mano.

⑩

Nivel 3
0,75 s.

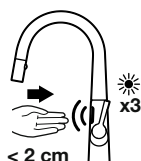

El LED emitirá 3 parpadeos por seg. durante 5 seg. Si se desea Nivel 3 (0,75 seg.), poner la mano a menos de 2cm Si no se desea este ajuste, no colocar la mano.

⑪

Nivel 4
1 s.



El LED emitirá 4 parpadeos por seg. durante 5 seg. Si se desea Nivel 4 (1 seg.), poner la mano a menos de 2cm. Si no se desea este ajuste, no colocar la mano.

EN 3.2 WATER FLOW DELAY TIME ADJUSTMENT

The faucet activates or deactivates when the hand is detected for at least 0.5 sec. (default setting). This time can be changed for installation requirements or user preferences.

⚠ This adjustment is only possible within the first 2 minutes after power supply connection

①

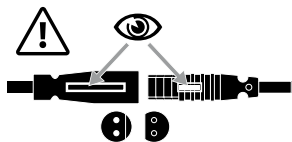

Unplug and plug the power supply. Within the first 2 minutes, proceed with the following steps.

②

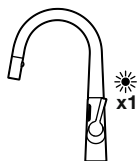

The LED blinks one time. Wait 5 sec. to start the adjustment process.

③

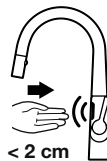

Place hand in front of the sensor closer than 2cm. for 5 sec. regardless of water flow.

④

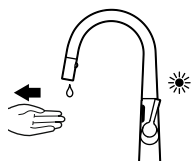

When the red LED of sensor starts to blink, remove hand. The water flow will stop, if it was open.

⑤

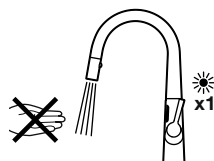

After 3 sec. the faucet starts water flow and the LED blinks 1 time per sec. during 5 sec. Do not place hand in front of sensor.

⑥

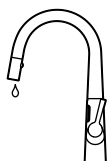

The faucet closes the water flow and the LED stops blinking for 3 sec.

⑦

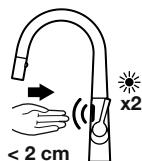

The faucet starts water flow and the LED blinks 2 times per sec. for 5 sec. within those 5 sec. place hand closer than 2 cm. The LED stops blinking and water flow stops. Remove hand before 3 sec.

⑧

Level 2
0.25 s.

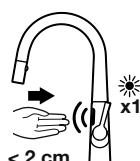

The LED blinks 1 time per sec. for 5 sec. To set Level 1 (0.25 sec.), place hand closer to 2 cm. from sensor. If this is not the desired adjustment, do not place hand.

⑨

Level 2
0.5 s.



The LED blinks 2 times per sec. for 5 sec. To set Level 2 (0.5 sec.), place hand closer to 2 cm. from sensor. If this is not the desired adjustment, do not place hand.

⑩

Level 3
0.75 s.

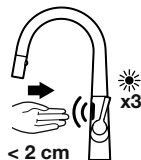

The LED blinks 3 times per sec. for 5 sec. To set Level 3 (0.75 sec.), place hand closer to 2 cm. from sensor. If this is not the desired adjustment, do not place hand.

⑪

Level 4
1 s.

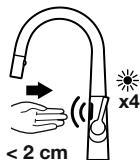

The LED blinks 4 times per sec. for 5 sec. To set Level 4 (1 sec.), place hand closer to 2 cm. from sensor. If this is not the desired adjustment, do not place hand.

ES 3.3 AJUSTE CIERRE AUTOMÁTICO DEL AGUA (AUTOSTOP)

El grifo cierra automáticamente el paso de agua a los 60 seg. (ajuste por defecto). Este tiempo puede variarse en función de los requerimientos de instalación o preferencias del usuario.

⚠ **Ajuste sólo posible durante los primeros 2 minutos tras la conexión eléctrica**

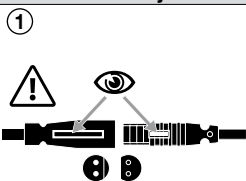

Desconectar y conectar la alimentación eléctrica. Durante los 2 primeros minutos, proceder con la secuencia indicada.

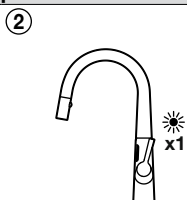

El LED emite un destello. Esperar 5 seg. para iniciar el proceso de ajuste.

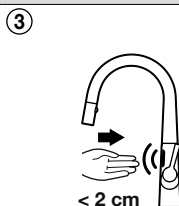

Colocar la mano frente al sensor a menos de 2cm. durante 5 seg. Es indiferente que haya o no flujo de agua.

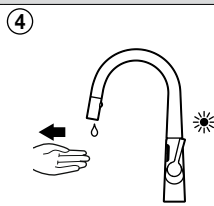

Cuando el LED del sensor empiece parpadear, retirar la mano. El paso de agua debe interrumpirse si estaba abierto.

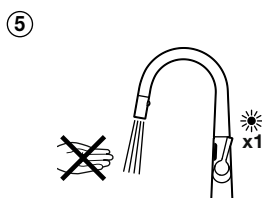

A los 3 seg. se activará el paso de agua y el LED emitirá 1 parpadeo por seg. durante 5 seg. No colocar la mano.

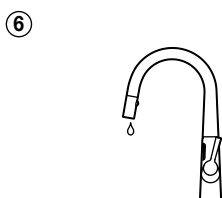

Se cerrará el paso de agua y el LED dejará de parpadear durante 3 seg.

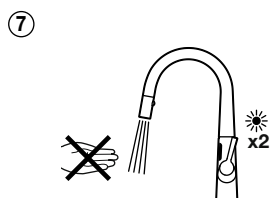

Se activará el paso de agua y el LED emitirá 2 parpadeos por seg. durante 5 seg. No colocar la mano.

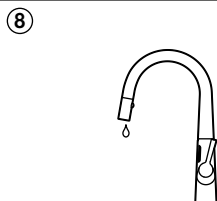

Se cerrará el paso de agua y el LED dejará de parpadear durante 3 seg.

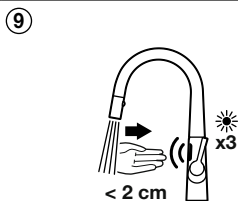

Se activará el paso de agua y el LED emitirá 3 parpadeos por seg. durante 5 seg, durante los cuales se debe colocar la mano a menos de 2cm. El LED dejará de parpadear y se cerrará el paso de agua. Retirar la mano antes de 3 seg.

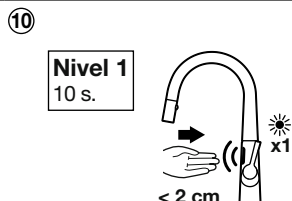

El LED emitirá 1 parpadeo por seg. durante 5 seg. Si se desea Nivel 1 (10 seg.), poner la mano a menos de 2cm del sensor. Si no se desea este ajuste, no colocar la mano.

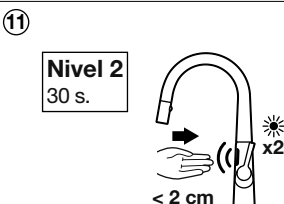

El LED emitirá 2 parpadeos por seg. durante 5 seg. Si se desea Nivel 2 (30 seg.), poner la mano a menos de 2cm Si no se desea este ajuste, no colocar la mano.

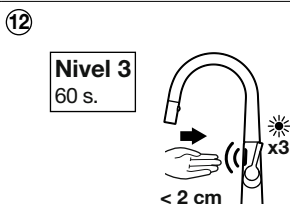

El LED emitirá 3 parpadeos por seg. durante 5 seg. Si se desea Nivel 3 (60 seg.), poner la mano a menos de 2cm. Si no se desea este ajuste, no colocar la mano.

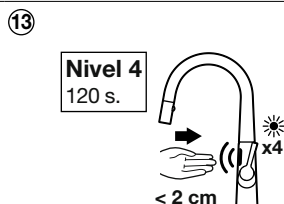

El LED emitirá 4 parpadeos por seg. durante 5 seg. Si se desea Nivel 4 (120 seg.), poner la mano a menos de 2cm. Si no se desea este ajuste, no colocar la mano.

EN 3.3 TIMEOUT ADJUSTMENT (AUTOSTOP)

The faucet deactivates the water flow automatically after 60 sec. (default setting). This time can be changed for installation requirements or user preferences.

⚠ Ajuste sólo posible durante los primeros 2 minutos tras la conexión eléctrica

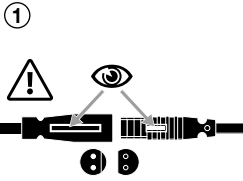

Unplug and plug the power supply. Within the first 2 minutes, proceed with the following steps.

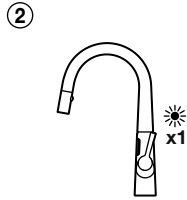

The LED blinks one time. Wait 5 sec. to start the adjustment process.

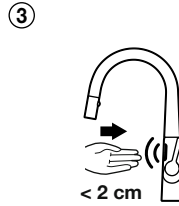

Place hand in front of the sensor closer than 2cm. for 5 sec. regardless of water flow .

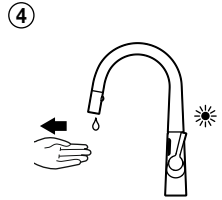

When the red LED of sensor starts to blink, remove hand. The water flow will stop, if it was open.

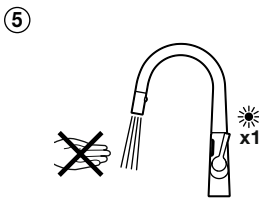

After 3 sec. the faucet starts water flow and the LED blinks 1 time per sec. during 5 sec. Do not place hand in front of sensor.

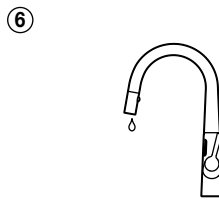

The faucet closes the water flow and the LED stops blinking for 3 sec.

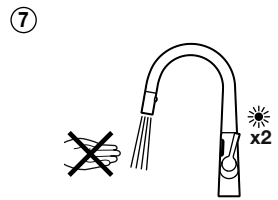

The faucet restarts the water flow and the LED blinks 2 times per sec. for 5 sec. Do not place hand.

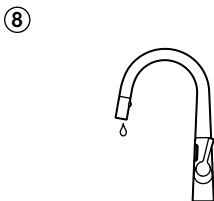

The faucet stops water flow and the LED stops blinking for 3 sec.

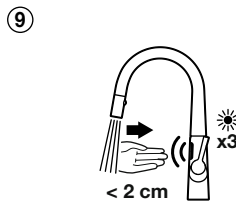

The faucet starts water flow and the LED blinks 3 times per sec. for 5 sec. within those 5 sec. place hand closer than 2 cm. The LED will stop blinking and water flow closes. Remove hand before 3 sec.

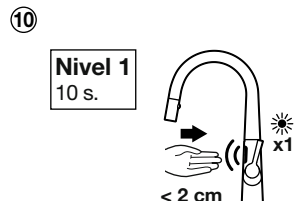

The LED blinks 1 time per sec. for 5 sec. To set Level 1 (10 sec.), place hand closer than 2 cm from sensor. If this is not the desired adjustment, do not place hand.

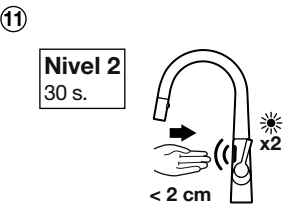

The LED blinks 2 times per sec. for 5 sec. To set Level 2 (30 sec.), place hand closer than 2 cm from sensor. If this is not the desired adjustment, do not place hand.

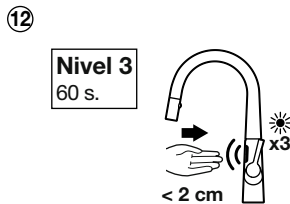

The LED blinks 3 times per sec. for 5 sec. To set Level 3 (60 sec.), place hand closer than 2 cm from sensor. If this is not the desired adjustment, do not place hand.

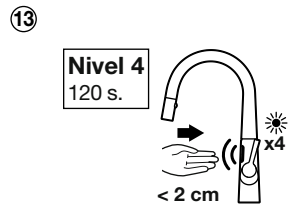

The LED blinks 4 times per sec. for 5 sec. To set Level 4 (120 sec.), place hand closer to 2 cm. from sensor. If this is not the desired adjustment, do not place hand.

ES 4. MODO LIMPIEZA

Para activar y desactivar el modo limpieza, seguir estos pasos:

①

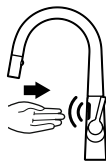

Colocar la mano frente al sensor a menos de 2cm durante 5 seg. El grifo cerrará el paso de agua y el sensor empezará a parpadear.

②

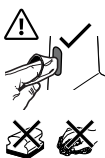

Se activa el modo limpieza, que previene el flujo de agua durante 5 minutos.

⚠ **No utilizar limpiadores u objetos abrasivos, especialmente sobre el sensor.**

③

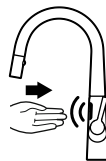

Para salir del modo limpieza, colocar la mano frente al sensor durante 5 seg. El grifo también saldrá del modo limpieza automáticamente a los 5 min. desde su activación y volverá su estado de funcionamiento normal.

EN 4. CLEANING MODE

To turn ON or OFF cleaning mode, follow these steps:

①

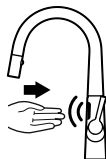

Place hand in front of sensor closer than 2 cm for 5 sec. Water flow will stop and the sensor will start blinking.

②

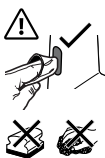

The cleaning mode will be activated preventing the faucet to open water flow for 5 min.

⚠ **Do not use abrasive cleaners or objects, specially on the sensor.**

③

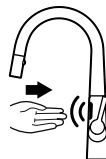

To exit cleaning mode, place hand in front of sensor for 5 sec. The faucet will also exit cleaning mode automatically after 5 min. from activation and return to normal status.

A5A8A2A..0

- 1 - 000000000
- 2 - 000000000
- 3 - 000000000
- 4 - 000000000
- 5 - 000000000
- 6 - 000000000
- 7 - 000000000
- 8 - 000000000
- 9 - 000000000
- 10 - 000000000
- 11 - 000000000
- 12 - 000000000

